

Igarapé

DADOS TÉCNICOS / CONSTRUCTION INFORMATION

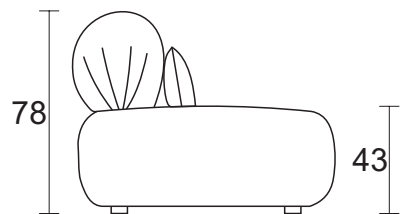

ASSENTO / *Seat*
Espuma / Fixo / Percinta
Foam | Fixed | Webbing

ENCOSTO / *Back*
Espuma / Fixo
Foam | Fixed

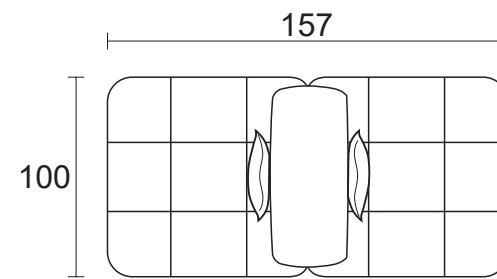
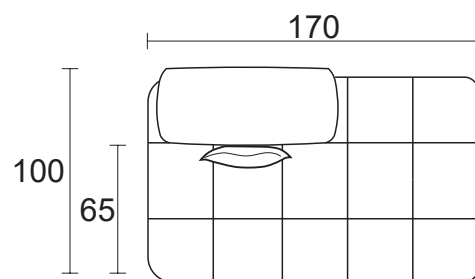
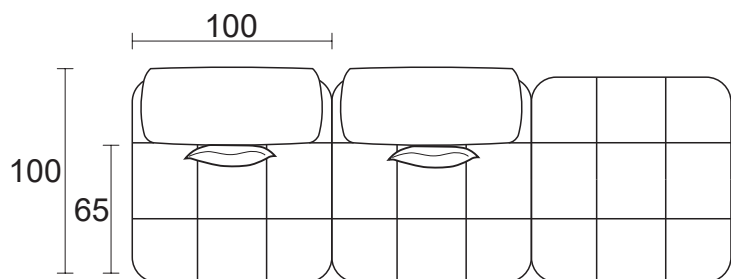

CONSOLE

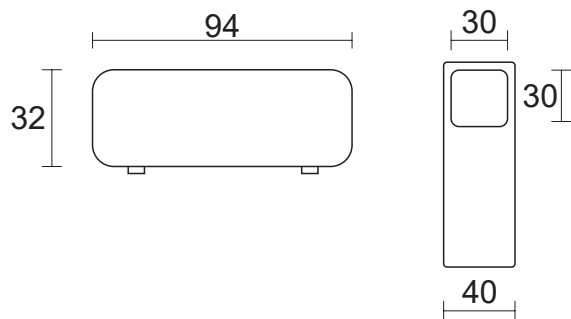

PUFE

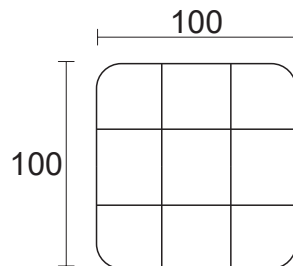

BANDEJA PARA ASSENTO

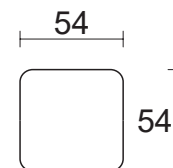

BRAÇO

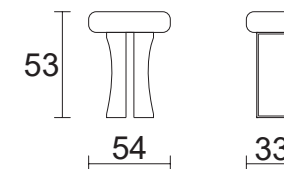

DADOS TÉCNICOS / CONSTRUCTION INFORMATION

ASSENTO / *Seat*

Espuma / Fixo / Percinta

Foam | Fixed | Webbing

ENCOSTO / *Back*

Espuma / Fixo

Foam | Fixed

S/BR 1,00 + S/BR 1,00 + PUFE 1,00 + BANDEJA PARA ASSENTO

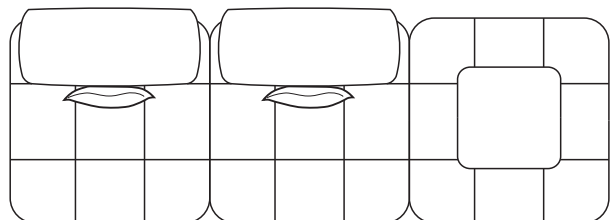

CHAISE FRONTAL 1,62 + S/BR 1,00 + S/BR 1,00

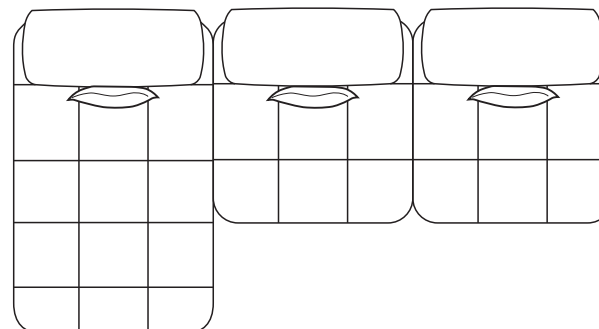

ILHA 1,57

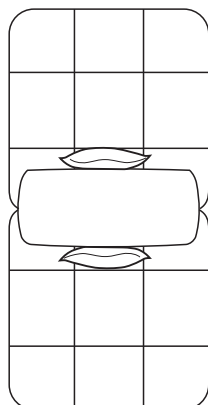

S/BR 1,00 + CHAISE LATERAL 1,70

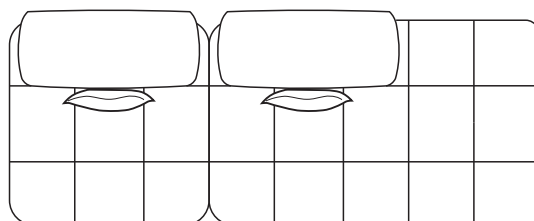

CHAISE FRONTAL 1,62 + S/BR 1,00 + PUFE 1,00

